



Your steel in good hands.



simple
personal
direct

Technical information on the topic

Environmental protection in hot-dip galvanizing

Our commitment to environmental protection



We decided to invest consistently in environmental protection more than 25 years ago. Since then, we have successfully transformed hot-dip galvanization, step by step, into an environmentally friendly process. On the following pages we would like to give you a comprehensive overview of the processes at our plants and present the environmental protection measures we have developed. We are particularly proud of the pioneering role we play in the field. For that the following milestones serve as examples:

- ▶ 1989: Introduction of DIN EN ISO 14001 and a central environmental officer for all of our plants
- ▶ 1991: Received the “Umweltpreis der Stadt Nürnberg” (environment prize presented by the city of Nuremberg) for our pilot plant, the first with a fully enclosed pre-treatment and galvanizing line
- ▶ 1992: All pre-treatment and galvanizing lines at new plants are enclosed
- ▶ 1994: Awarded the “Umweltmedaille des Freistaates Bayern” (Environment Medal of the Free State of Bavaria, Germany)
- ▶ 2001: Fitted the pre-treatment lines at all new plants with air scrubbers
- ▶ 2004: Awarded the “Health & Safe Environment Prize” from the Czech Republic for our plant in Velké Meziříčí (Czechia)
- ▶ 2014: Validation of all plants in the German-speaking region according to the EMAS directive (Eco-Management and Audit Scheme)
- ▶ 2017: “EMAS Award” of Germany for the WIEGEL Group

In future, we want to maintain our reputation as a pioneer and model company in our sector and continue to work at perfecting our processes. Our focus lies concentrated on reducing potential harm to the environment as well as on minimizing risks and protecting our employees. Transparency and accountability are our top priorities.



a In 1994 we were awarded the Environment Medal of the Free State of Bavaria for our plant in Nuremberg.

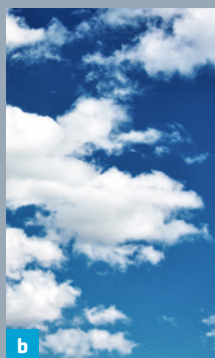

b The natural basis of our existence: air, water, soil.



c More than just “greenwashing”: our commitment to environmental protection.



d In order to gain EMAS validation, companies have to meet certain standards in their environmental measures and to demonstrate this at regular intervals.



A pioneer in the industry

“Hot-dip galvanization” – if anyone has any idea what this term actually means, they usually think of heat, smoke and toxic fumes. The thought conjures up images of “classical industrial plants” and in some peoples’ mind even smoking chimneys, noisy machines and polluted water. To put it briefly, “hot-dip galvanizing” and “environmentally friendly” wouldn’t generally have been seen as a pair of terms that belonged together to an unbiased observer. This image of the galvanizing industry is shaped by a past that is now long gone. Modern hot-dip galvanizing at WIEGEL is very different.

Not quite the same as baking muffins ...

Now of course a metallurgical process, which involves steel being dipped in a molten metal bath at 450 °C, is entirely different to running a bakery, from an environmental point of view. In this

brochure we would like to show you the challenges we face and the technology, methods and processes we apply to meet these challenges. This will show you just how much has changed in the last few decades in the field of hot-dip galvanizing when it comes to environmental protection.

Here at WIEGEL we are pleased to have contributed significantly to this positive development. Time and time again, we have succeeded in setting a good example when it comes to protecting the environment, preserving our resources and redefining the state of the art in our industry with trend-busting innovations.



a



b

a b Thankfully, such scenes are now a thing of the past: a few decades ago, hot-dip galvanizing was still a comparatively polluting and often hazardous job. There were neither emission protection measures, nor were any particular occupational health and safety measures taken.



c



d

c d Now, hot-dip galvanizing is not only considered to be the most environmentally friendly method of corrosion protection in terms of longevity and conservation of resources, but the production conditions also meet the strictest standards or even exceed their requirements.

Material and energy flows

Hot-dip galvanization is a “hot dipping process”, which involves metallic workpieces (almost always steel) are dipped into a vat of molten zinc at a temperature of 450 °C for several minutes. This causes iron-zinc alloys of varying composition to form on the wetted surfaces of the workpiece, which protect the workpiece against corrosion (rust) for decades. This process causes emissions of exhaust gases, smoke and dust.

To keep a volume – depending on the size of the plant – of approx. 40 to 100 m³ of zinc in a zinc kettle in a molten state permanently, a considerable amount of heat energy is required, some of which escapes into the atmosphere as waste heat.

Prior to the actual galvanization, a chemical pre-treatment of the workpiece is also required, which is also a dipping procedure performed in large baths and which we will go into further detail later. This also results in fumes (hydrochloric acid, ammonia).

Last but not least, the workpieces are also delivered and shipped, stored and transported within the plant, which results in noise and exhaust gases to a certain degree.

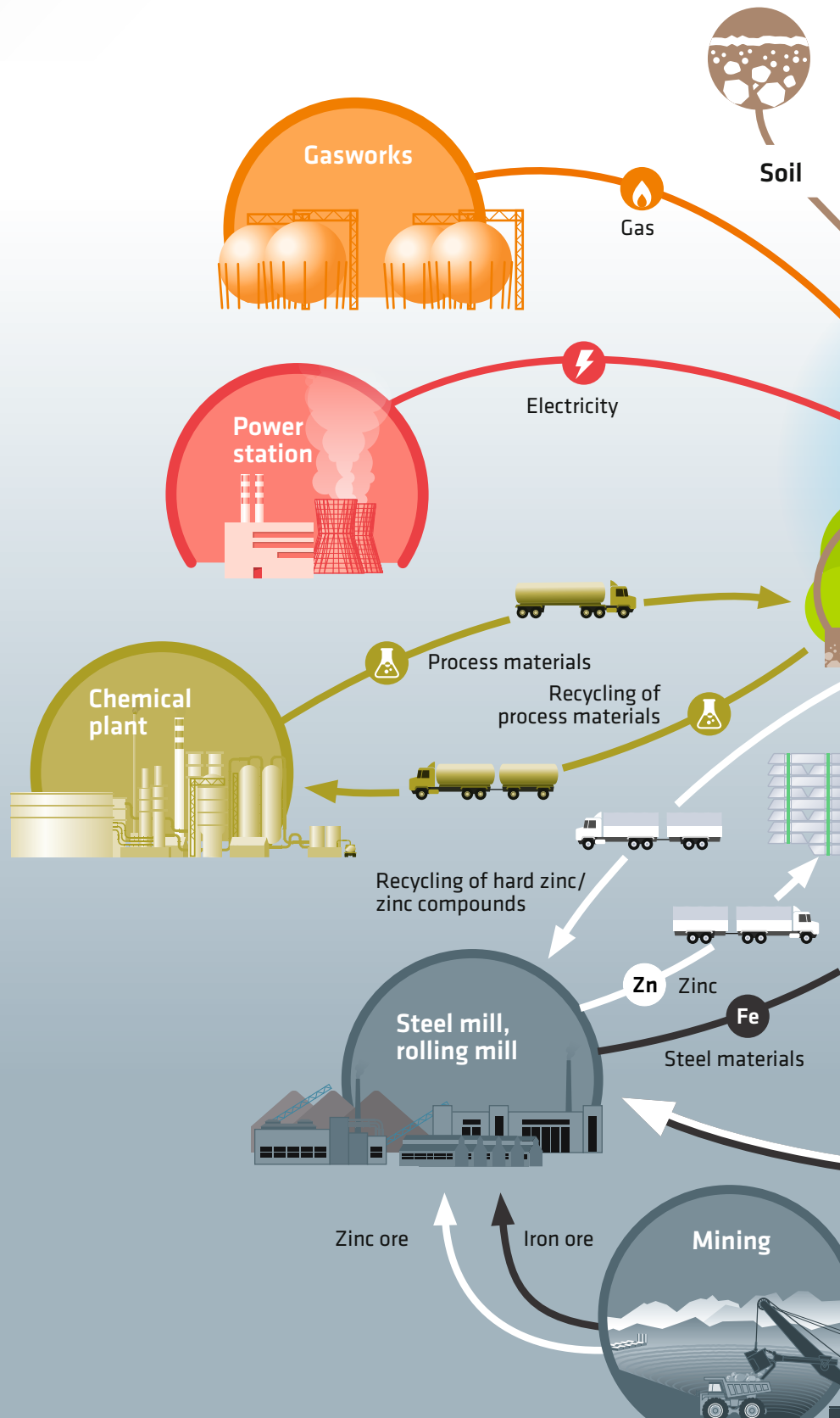

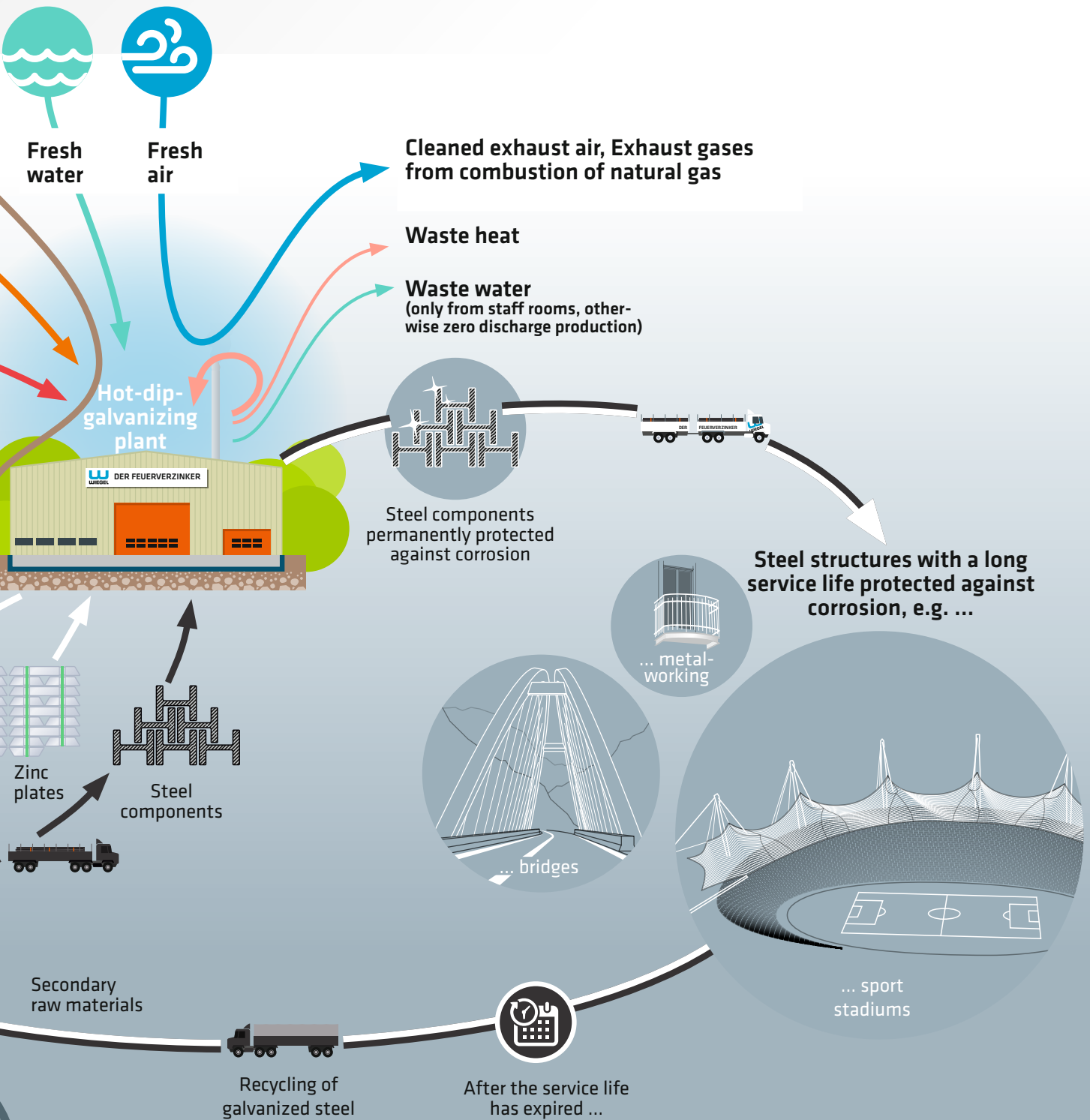

Active environmental protection

An example from plant technology: Exhaust air purification in the galvanizing line

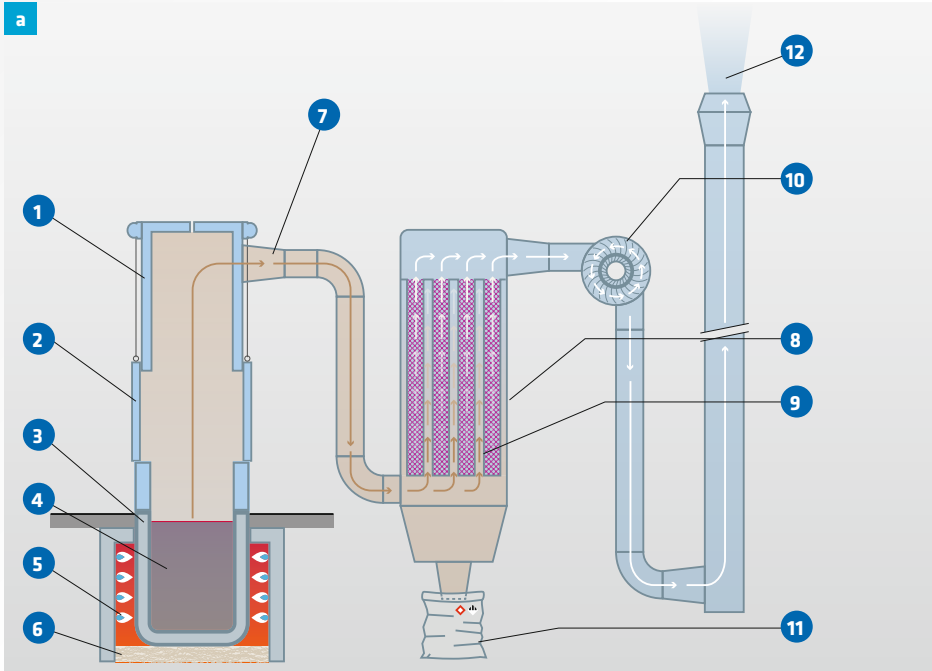

a Unladen zinc bath. There is negligible dust and smoke development above the zinc bath. The workpiece being galvanized is inserted into the enclosure at the top of the furnace.

A large filter unit for
a 15 m molten zinc bath.

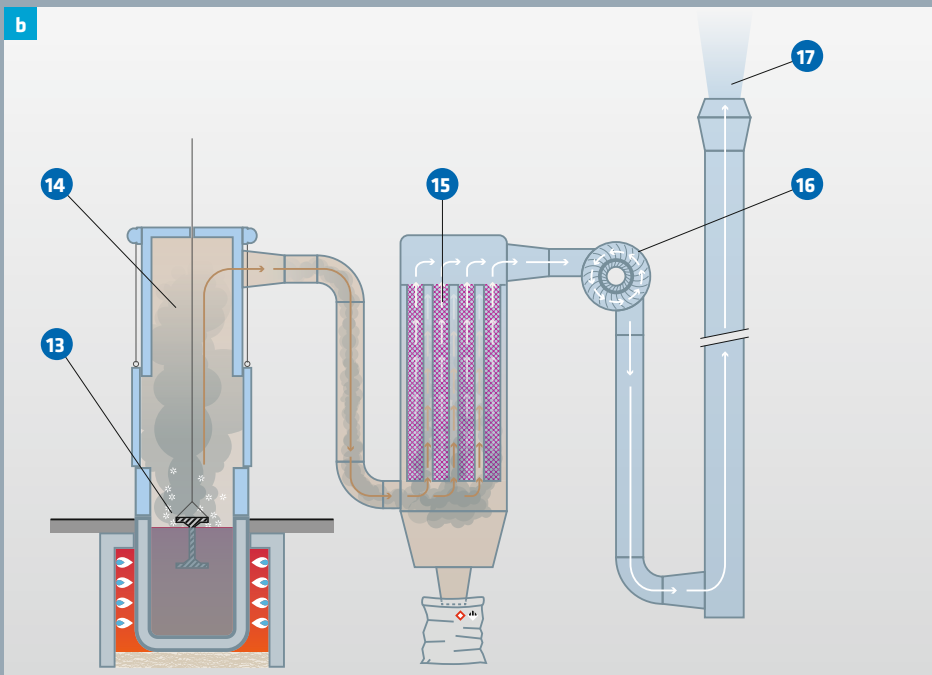

b As the workpiece is immersed in the zinc bath, a lot of smoke and dust are produced and minute particles of metallic zinc can also splash up. The exhaust air over the zinc bath contains up to 1,000 mg of particles per cubic metre. The exhaust system is running at full speed. The exhaust air is sucked through the filter at a very high volume flow rate, where it is cleaned. After filtering, the exhaust air only contains approx. 1 mg/m³ of particles.

With increasing dwell time in the zinc bath the smoke and dust already starts to abate, but the exhaust system continues running at full speed.

Legend for **a** to **c**

- 1** Enclosure
- 2** Movable side gates
- 3** Galvanizing kettle
- 4** Molten zinc bath at 450 °C
- 5** Burner
- 6** Insulation
- 7** Exhausted air flow
- 8** Filter unit
- 9** Filter bags
- 10** Fan
- 11** Filter dust collector
- 12** Exhaust air
- 13** Production of smoke, dust and zinc splashes
- 14** Dirty air (approx. 1,000 mg of particles per m³)
- 15** Purification of the dirty air by the filter unit
- 16** The fan generates a high volume flow rate of up to 50,000 m³/h
- 17** Clean exhaust air (only approx. 1 mg of particles per m³, **well below the limit value specified by TA Luft**)
- 18** The filter media are gradually blocked as galvanizing proceeds
- 19** The filters are cleaned depending on the concentration of particles
- 20** "Shaking out" of the filter by vibrating it over the filter dust collector
- 21** The filter dust collected are recycled and used as secondary raw materials

The strong suction from the extractor prevents emissions from escaping from the enclosure in an uncontrolled way.

Filter dust collector.



The enclosure of the galvanizing kettle is only opened for removal and inspection of the workpieces. Extractors ensure that the exhaust air is collected in a controlled way and cleaned by the filter unit.

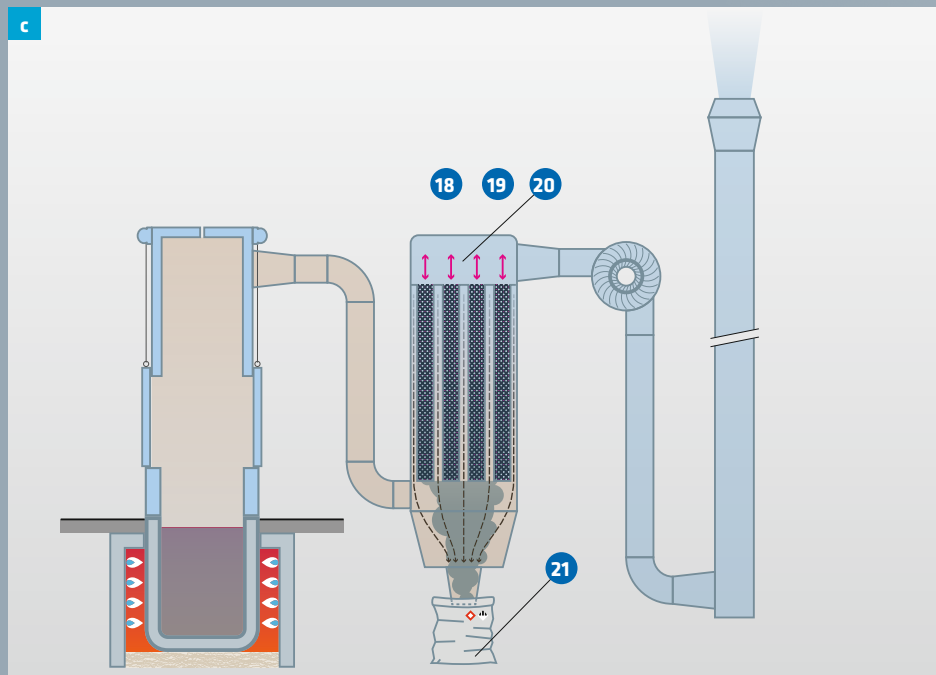

c Depending on the level of particulates produced during the galvanizing process, the filter medium is flushed off periodically. The residues fall into a collection bin and are recycled and used as secondary raw materials.

An animation of the exhaust air purification process in the galvanizing line, can be found here:

<https://youtu.be/i8ysmlZKtDw>



Active environmental protection

An example from plant technology: Exhaust air purification in the pre-treatment line

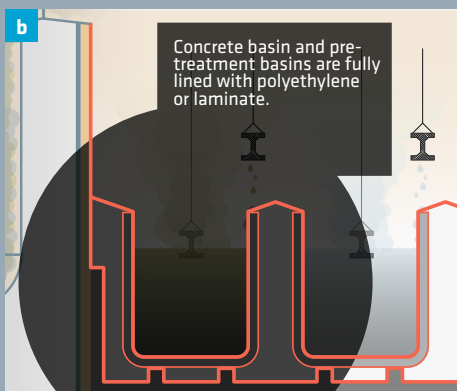
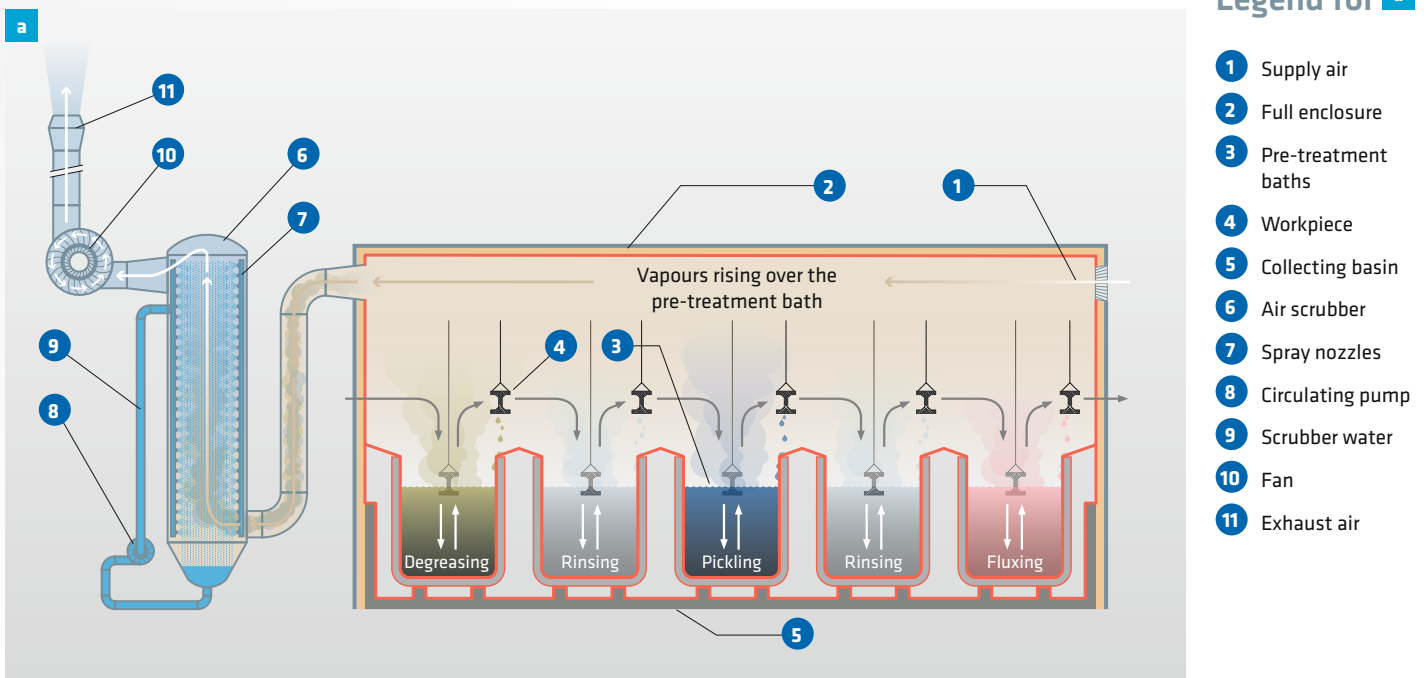

a It is primarily hydrochloric acid vapour that escapes from the baths in the pre-treatment line, some of which are heated, and to a much lesser extent ammonia fumes, which need to be removed from the air in the enclosure. The enclosure is slightly underpressurised. This prevents fugitive emissions out of the unit, even while the pre-treatment line is being loaded and unloaded.

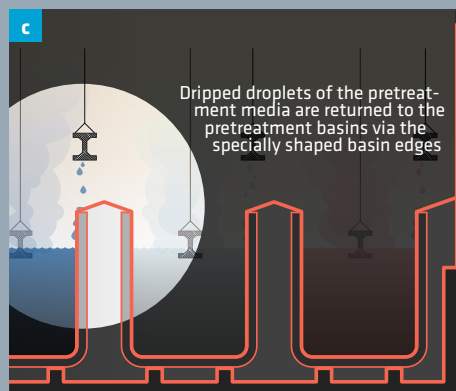

b Because some of the chemicals used for pre-treatment are substances which are hazardous to water, the pre-treatment baths are hermetically sealed. In addition, the pre-treatment baths also have a collecting basin with an acid-proof lining, which has a capacity of over 100%.

c The baths are designed in such a way that no drips can drip back into the collecting basin, which normally remains clean and dry.

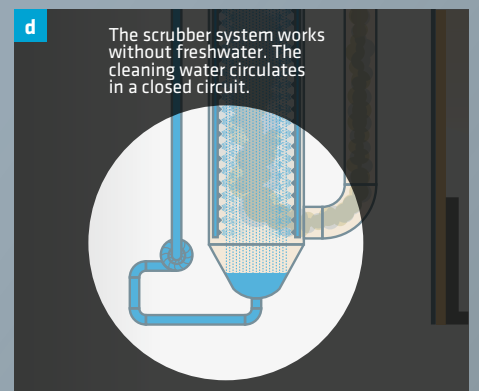

d The exhaust air itself is cleaned by an air scrubber, which has zero discharge of waste water. Hydrochloric acid is added to the scrubber water before it is used in the pickling process.



Hydrochloric acid

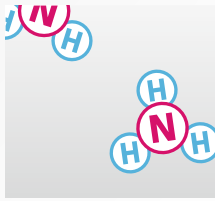

Ammonia

The workpieces are prepared for galvanizing in the pre-treatment line. The operations involved include removal of grease and oil, pickling with dilute hydrochloric acid to remove rust and scale, as well as immersion in flux (fluxing), which subsequently ensures even and fast wetting of the workpiece with the

molten zinc. Since some processes take place faster at higher temperatures, some of the baths are heated. Depending on the temperature, some harmful vapours are given off from the heated baths, which must not escape into the environment.

The enclosure of the pre-treatment line seen from the outside.



The pre-treatment line seen from the inside with polyethylene enclosure.



One of the chemicals used in the flux bath, zinc chloride ($ZnCl_2$), is classified as a substance hazardous to water. Thus means that the baths need to have an impermeable plastic lining and also be in an impermeable collecting basin, which has sufficient retention capacity to hold all of the media from the baths in the event of an emergency.



g The pre-treatment line baths seen from below. Both the baths as well as the collecting basin are completely coated with acid-proof laminate.

An animation of the exhaust air purification process in the pre-treatment line can be found here:

<https://youtu.be/PBqRnbm5Z0c>



h i Air scrubber with spray tower.

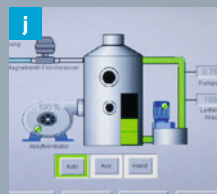

j Air scrubber controller.

Active environmental protection

An example from plant technology: Waste heat recovery in the galvanizing line

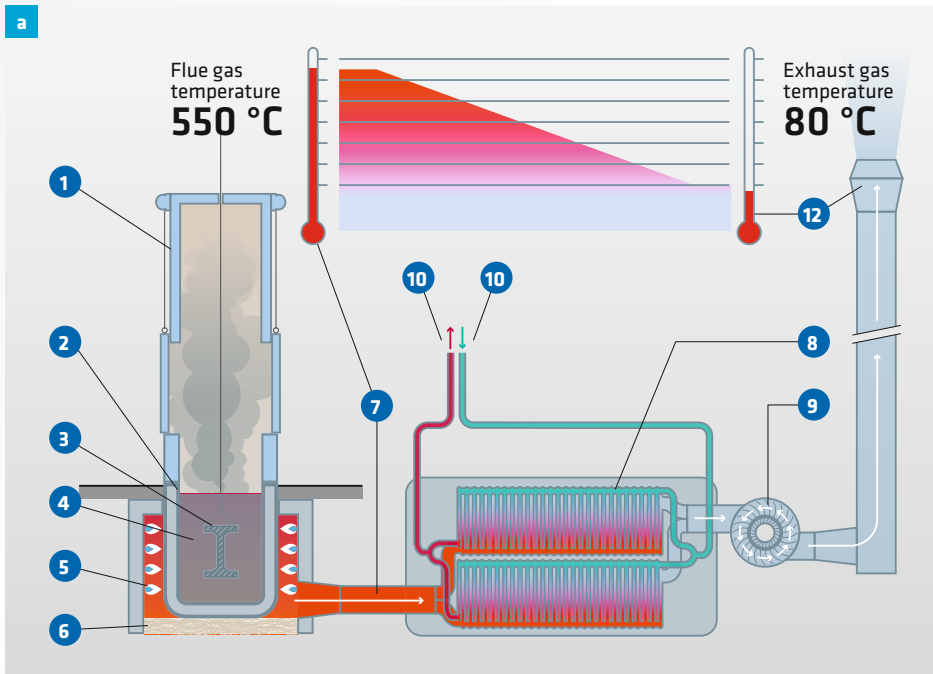

Legend for **a**

- 1 Enclosure with movable gates
- 2 Zinc kettle
- 3 Workpiece
- 4 Molten zinc bath at 450 °
- 5 Burners
- 6 Insulation
- 7 Flue gas duct
- 8 Air/water heat exchanger
- 9 Fan
- 10 Inflow (from consumer)
- 11 Return flow (to the consumer)
- 12 Exhaust air

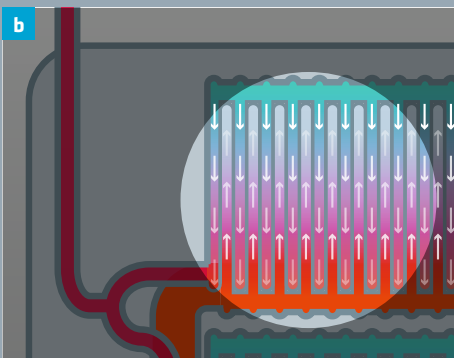

b Using the counter-current principle, very high heat transfer efficiency can be achieved.

c Plate heat exchanger

d The recovered waste heat can be used as process heat for heating the pre-treatment baths or for heating staff rooms.



At a temperature of approx. 550 °C, the flue gases in the combustion chamber under the zinc kettle still contain a lot of thermal energy, which in the past would have escaped from the chimney unused. Using heat exchangers, it is possible to recover approx. 80% of this energy and use it for other purposes, e.g. as process heat for heating the pre-treatment baths or the drying furnace in the pre-treatment line or for heating staff rooms.

An animation of the heat recovery process in the galvanizing line can be found here:

<https://youtu.be/6sd6Xd128o4>



Active environmental protection

An example from plant technology: State of the art burner control system on the zinc kettle



a To minimise flue gas losses low-load operation is prevented. Once the target temperature for the bath is reached, all of the flaps are closed, too. (Thermos flask principle)

b All of the processes are permanently monitored to ensure that the galvanizing plant is operated energy efficiently and with low emissions.



c Looking into the combustion chamber. On the long sides of the zinc kettle there are several burners arranged in series.

d Each burner is regulated individually.



e Two temperature probes measure the temperature of the molten zinc bath.

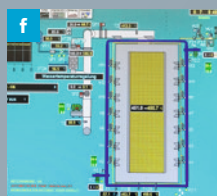

f Control panel of the digital furnace controller.

Occupational health and safety

Because our employees are our most important resource!



Ultimately, the success of all the precautions and processes depends on competent and motivated employees, which is why we not only provide intense training, but also regular in-service training and a pleasant working atmosphere. Safeguarding the health of

our employees is especially important to us. For us, occupational health and safety is an essential part of applied environmental protection.



a Detailed work instructions reduce the risk of accidents

b A visor and protective clothing must be worn at the zinc kettle!

c In the event of an accident, first aid boxes and emergency showers are close at hand.

d Bright energy-saving workplace lighting.

e Load securing? Thinking along with you, even beyond the factory gates ...

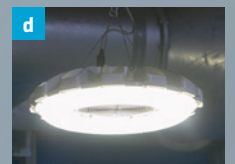
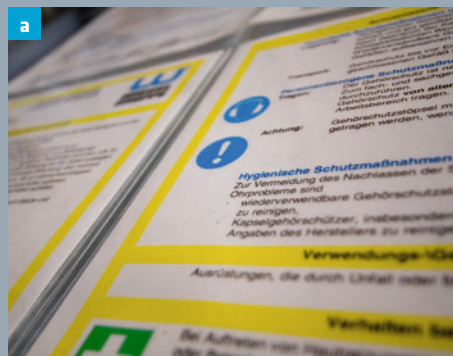

What others say about us ...

Our commitment to the environment is well received by the general public.



Alexander Hofmann explains to MdL Eveline Lemke the advantages of hot-dip galvanizing



Dr. Monika Kratzer

“When it comes to environmental protection, the Wiegel Group is exemplary and counts as one of the pacemakers of the entire industry.”

Dr Monika Kratzer
principal at the Bavarian State Ministry of the
Environment and Consumer Protection
in her welcoming address on 8 May 2015

“Wiegel is a genuine ideal of an industrial enterprise”

Mrs Eveline Lemke (Party: Alliance 90/The Greens),
Minister for Economic Affairs, Climate Protection, Energy
and Spatial Planning of the State of Rhineland Palatinate,
in Neuwied on 11 August 2015

“The NUV is convinced that the hot-dip galvanizing plant in Neuwied is one of the most modern in the whole of Europe – including in the field of environmental protection, since due to the experience gained by Wiegel, additional monitoring equipment is in operation, benefiting both the process flow and environmental protection equally.”

Hendrik Hoerber,
first chairman of the
Neuwieder Umweltschutz e.V. (NUV)
in July 2015



The mighty 15-meter kettle in Neuwied

Our motivation



Interview with Alexander and Michael Hofmann: why WIEGEL invests in environmental technology and resource efficiency

Wiegel is frequently described by others as a pioneer and ideal enterprise in environmental protection when it comes to hot-dip galvanization of steel. How did Wiegel embark on this path?

“In the 1980s, the first major environmental law on air quality control was passed in Germany. Wiegel – as a rather small group of companies of regional importance at the time – was one of the few to take this seriously right from the outset: hot-dip galvanizing plants were amongst the most polluting factories that existed back then. It was clear to us that this situation could not continue for much longer, and any family-run company taking a long-term view must have seen things the same way, really. Today

it is referred to as ‘sustainability’, but that’s nothing new.

Our main plant at our corporate headquarters in Nuremberg was rather dated and needed to be replaced. Unfortunately, clean and sustainable processes and plants were completely unknown in the industry at the time. We launched a pilot project in cooperation with the Bavarian Environmental Protection Agency in Munich and simply developed our technologies ourselves.

In 1990 we built a big new 15.5 m hot-dip galvanizing plant on the edge of the city centre of Nuremberg, with the first completely enclosed and sealed working areas and closed-loop systems as well

as the latest technologies and innovations. After overcoming a few teething problems, it soon became clear to us that not only had we successfully solved the most urgent environmental problems when it came to air pollution control, but had also achieved much more: safety and cleanliness, working conditions, as well as efficiency and productivity and value retention of the new and very expensive facilities had been improved by orders of magnitude. The solution to the ecological problems also gave us a decisive economic advantage.

Right after that, we built another medium-size plant of the same type with a 7 meters long galvanizing kettle in Breitengüßbach, near Bamberg, in 1991. This laid the inno-

What are – in summary – the main reasons for your success?

“In the long-term, we constantly strive to ...

- ▶ ... view challenges, whether they are caused by environmental issues or due to changes in technology and society, not as a burden, but as an opportunity to improve.
- ▶ ... approach each task with expert understanding, but also with great passion and enthusiasm.
- ▶ ... stay down-to-earth, take a long-term and socially responsible approach, with honesty and reliability as our core values, putting people first and taking our employees, customers and suppliers as well as all other business partners seriously and acting fairly.
- ▶ ... offer our employees good and safe jobs. Safe in two senses: secure and not dangerous, because we attach just as much importance to occupational health and safety as we do to environmental protection.”

And what does the future hold?

“We aim to continue our successful course! We want to constantly improve – for a better future – economically and environmentally aware..

In a few years – before the expiry of the transitional period for the new industrial emissions Directive, which calls for compliance with the current state of the art at all times – we will already have retrofitted all of our existing plants so that they meet the standards for new installations or will have completely replaced them with new plants. This is the best possible way to safeguard our future.

Thank God our world is always full of change, of challenges and thus of opportunities just waiting to be taken, with understanding, with heart and soul, and with pleasure, because: it’s fun to be successful and enjoying what you do leads to success.”



The grandsons of the company's founder Hans Wiegel, current owners and board members: Alexander (left) and Michael (right) Hofmann.

vative groundwork for the truly remarkable development of the company.

In other words, directly overcoming the challenges facing environmental protection in terms of ecological and economic improvements is one of the key foundations of our continued success."

Short-term great success is all well and good, but it is generally much harder to stay on course and maintain such success in the long term. How did Wiegel manage to achieve this?

"First of all, by systematically implementing our initial successes. We achieved this by replacing obsolete plants with new plants in Germany. In addition, we invested early in Czechia, which adopted a completely new course after the fall of the Iron Curtain.

But at the same time, we continued to consistently develop the business. We have never been satisfied to rest on our previous success. For us, getting better has always taken precedence over growing bigger! We switched our production to a process that is free of waste water and took a close look at our processes and the media we use and optimised them, created closed-loop cycles, turned waste into recyclable materials, and

minimised emissions, saving increasing amounts of feedstock and energy, as a result of which we have continuously improved our efficiency and performance.

We have consistently adhered to both principles: development and implementation.

Also, we invested almost all the money we earned in further improvements and new, clean and efficient facilities. This enabled the Wiegel Group to grow to about eight times the size it was before the founding innovation in 1990 – all from its own funds."

And what would you recommend – from your experience – to other companies?

"That's simple! Go your own way, like we went ours, as described above. Take responsibility for your company, your employees and beyond that for our environment and our society. You can achieve great success with this approach, and make an important contribution, not just for yourself, but also for our society and our environment – and that's fun."

"Signed and sealed": Quality that you can rely on.



The successful EMAS validation of all the WIEGEL plants in the German-speaking region is just one more step on the road towards even greater environmental commitment.

Test us!

Because openness creates trust.

Take our word for it: we don't just pay lip service to environmental protection, it is a matter which is close to our hearts.

Here you can tear out or photocopy our environmental checklist. The environmental checklist addresses a number of environmentally relevant aspects relating to hot-dip galvanizing plants as well as documenting the current sta-

te of the art, the inspection requirements and the relevant certifications.

You can also download our environmental checklist from:

<https://goo.gl/h446nG>





Environmental checklist

Property	WIEGEL hot-dip galvanizing	My rating
Pre-treatment line:		
Pre-treatment line completely enclosed	+	<input type="checkbox"/>
Enclosure of the pre-treatment line meets latest standards: plastic or laminate	+	<input type="checkbox"/>
Pre-treatment line exhaust system with air scrubber	+	<input type="checkbox"/>
Separation within the pre-treatment line from the pre-treatment room and the collecting basin (dry collecting basin)	+	<input type="checkbox"/>
Operation of the pre-treatment line is free of waste water	+	<input type="checkbox"/>
Pre-treatment line collecting basin with increased capacity	+	<input type="checkbox"/>
Pre-treatment line collecting basin - lining iaw. latest standard: plastic or laminate	+	<input type="checkbox"/>
Galvanizing line:		
Galvanizing line completely enclosed	+	<input type="checkbox"/>
Enclosure of the galvanizing line meets latest standards: steel structure	+	<input type="checkbox"/>
Galvanizing line exhaust system with filter system	+	<input type="checkbox"/>
High efficiency heat exchanger in the galvanizing furnace flue gas system (recovery of 80% of the waste heat)	+	<input type="checkbox"/>
Certifications:		
Environmental management in accordance with ISO 14001	+	<input type="checkbox"/>
Company-wide EMAS validation	+	<input type="checkbox"/>
Inspections:		
Regular inspections performed by technical experts meets the German Federal Water Act	+	<input type="checkbox"/>
Miscellaneous:		
<input type="text"/>	<input type="checkbox"/>	<input type="checkbox"/>
<input type="text"/>	<input type="checkbox"/>	<input type="checkbox"/>
<input type="text"/>	<input type="checkbox"/>	<input type="checkbox"/>
<input type="text"/>	<input type="checkbox"/>	<input type="checkbox"/>
<input type="text"/>	<input type="checkbox"/>	<input type="checkbox"/>

Published by:
WIEGEL Verwaltung
GmbH & Co KG

Hans-Bunte-Straße 25
D-90431 Nürnberg
Germany
Tel.: +49 (0)911 3 24 20-200
e-Mail: info@wiegel.de

Last updated: April 2017



Zinc – an indispensable metal

Versatile, durable, reliable

Although zinc has been known since antiquity, it was not until the invention of hot-dip galvanizing (Malouin 1742) and in particular the development of the pre-treatment of the steel by

pickling (Sorel 1849) that it rapidly came into widespread use in the middle of the 19th century. Since then, zinc has become indispensable for innumerable technological applications, although

the lion's share is still used for corrosion protection applications such as hot-dip galvanization.



a Over the rooftops of Paris: zinc. By the end of the 19th century 90% of the roofs were already covered with zinc sheet. The rooftop landscape of Paris may soon be declared part of the UNESCO world cultural heritage.



b Zinc is still widely used in architecture today in the form of galvanized steel supporting structures.

c Indispensable in steel construction: hot-dip galvanized steel.



d Everyone is talking about the weather – not us!

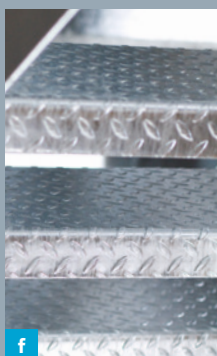

e Hot-dip galvanized steel structures make architecturally demanding solutions possible.

f Material-compatible appearance and attractive surfaces thanks to hot-dip galvanization.



g h When reliability and durability are paramount: hot-dip galvanized steel makes extensive infrastructure projects possible.

Corrosion protection to outlast generations



The duration of the protection provided by hot-dip galvanization depends on the thickness of the coating as well as how corrosive the conditions which the work-piece is subjected to are.

Protection for over 50 years under normal environmental conditions such as town or country air is typical, but even under extremely harsh conditions such as for offshore applications or aggressive

industrial atmospheres it can provide lasting protection for decades.

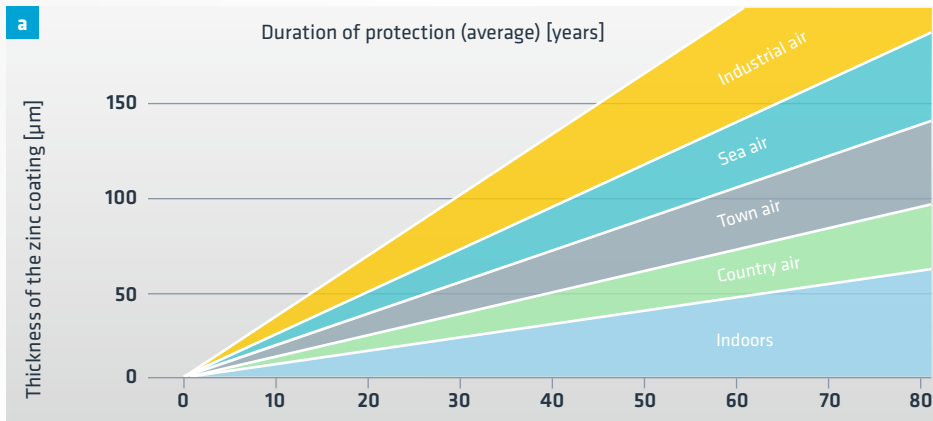

a Attainable duration of protection of zinc coatings depending on layer thickness and weathering.

b Professional hot-dip galvanization can even withstand aggressive environmental influences for decades.

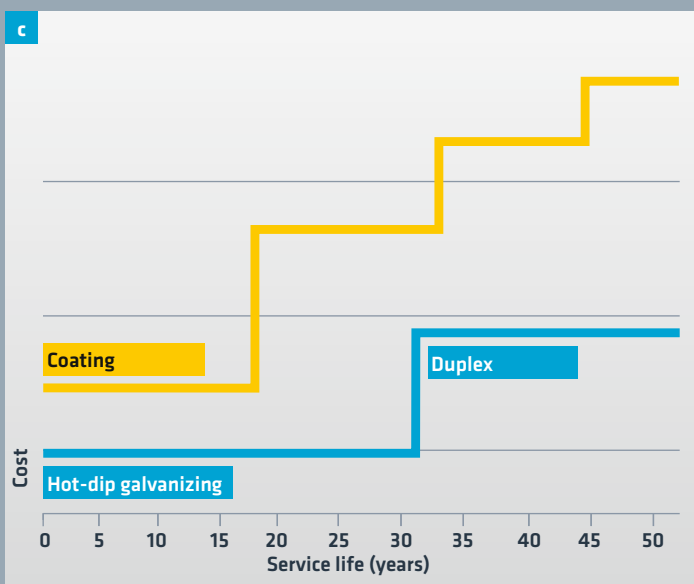

c Cost comparison of conventional processes with hot-dip galvanizing depending on the service life

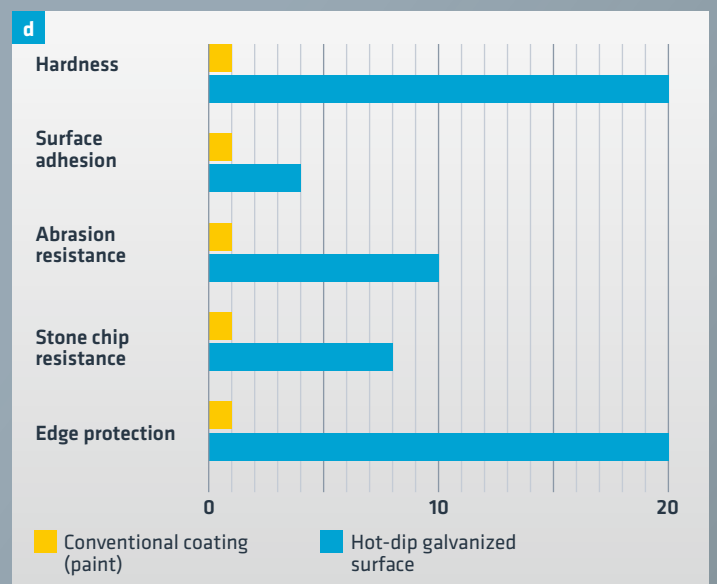

d Comparison of conventional coating with hot-dip galvanizing in terms of resilience to various conditions.

Convincing environmental performance

Zinc is a naturally occurring mineral element. Steel and zinc are raw materials that are ideal for recycling at the end of their useful lives.

According to estimates, the economic damage caused by corrosion amounts to about 4% of the GDP. Metal production is a highly energy intensive business, which in turn results in high CO₂ emissions: approx. 9,000 MJ ¹⁾ are needed to produce 1 t of steel, 1 t of zinc approx. 16,000 MJ. However, only approx. 50 kg of zinc are needed to hot-dip galvanize 1 t of steel, meaning that the zinc only accounts for about 10% of the total energy contribution to hot-dip galvanized steel. If you now consider that this system enables the service life to be extended by 3 – 5 times

in comparison to unprotected steel, this results in energy savings of approx. 24,000 – 44,000 MJ per ton of steel not needed to replace corroded steel ²⁾. This thus results in a considerable reduction in CO₂ emissions, meaning that hot-dip galvanizing is environmental protection in action!

In a pilot study comparative lifetime balances were drawn up for a standardised balcony construction. Hot-dip galvanizing was compared with a conventional coating. Here again, hot-dip galvanizing performed considerably better in the categories of total energy consumption, warming and acidification potential as well as photochemical ozone formation (see Fig. e). The longer service life of the



hot-dip galvanized steel contributes to this improved performance.³⁾

A final advantage of hot-dip galvanizing, which should not be underestimated, is the fact that, in contrast to other methods, no servicing or maintenance is required during its service life.

¹⁾ MJ = Megajoule

²⁾ Study by the International Zinc Association, Brussels

³⁾ "Leitfaden Feuerverzinken und Nachhaltiges Bauen" (guidelines on hot-dip galvanization and sustainable building, p. 33

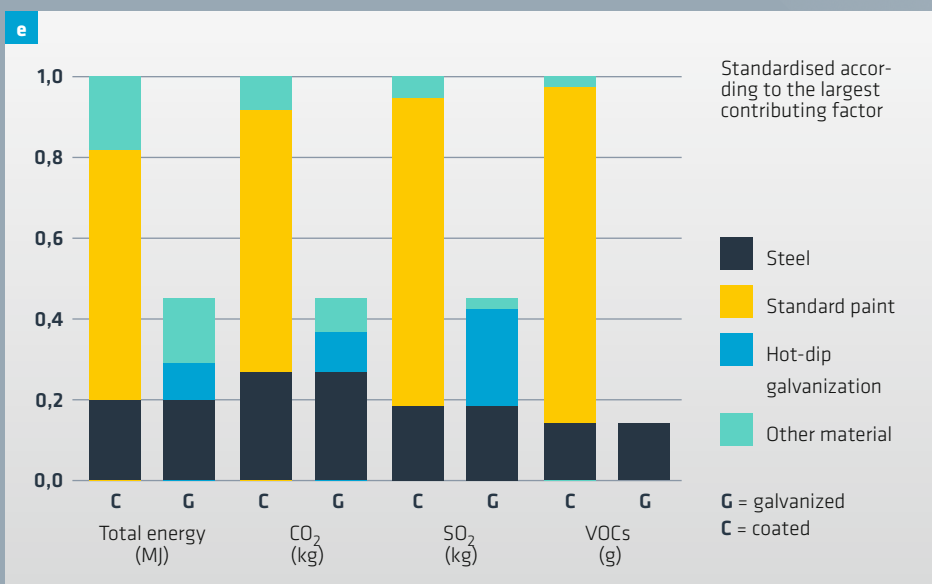

e Comparison of selected environmental impacts of a conventional coating process with hot-dip galvanization over the entire useful life of the system.



f In terms of environmental friendliness, low maintenance and economic viability, hot-dip galvanizing is superior to other coating systems.



g The economic costs of corrosion are immense.



© Patzita: photocase.de

Image credits:

All pictures from internet sources are licensed under the Creative Commons License: flickr.com, de.wikipedia.org, pixabay.com
The copyright credits are quoted by each photo



Stock photos from: fotolia.de, istockphoto.de, photocase.de. The copyright credits are quoted by each photo

All others:
WIEGEL Verwaltung GmbH & Co KG,
in medias res Marktkommunikation GmbH

Published by:

WIEGEL Verwaltung
GmbH & Co KG

Hans-Bunte-Straße 25
D-90431 Nuremberg
Germany

Tel.: +49 (0)911 3 24 20-200
e-Mail: info@wiegel.de

Last updated: April 2017



www.wiegel.de

www.wiegel.at

www.wiegel.cz

www.wiegel.sk